

6.5" elastic for waist

On Fold

FID Pants Pattern
(*shorter legs to go inside boots,
and with elastic waist)

FID Belt Pattern

Buckle Notch

A Attach lower part B

A B
Lower part of pants leg
Attach to upper part

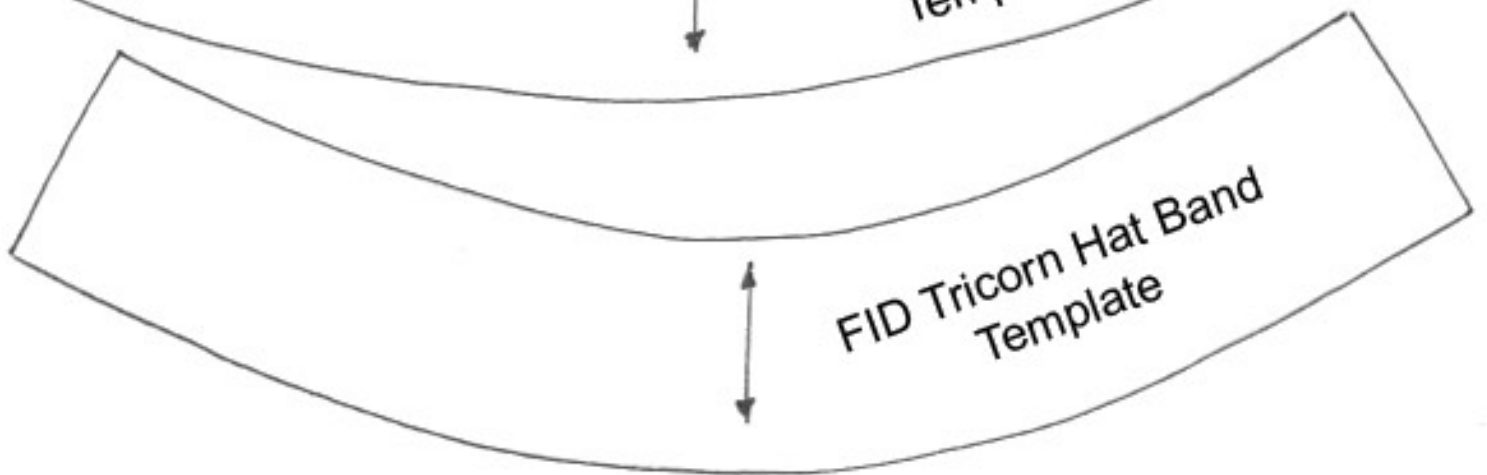
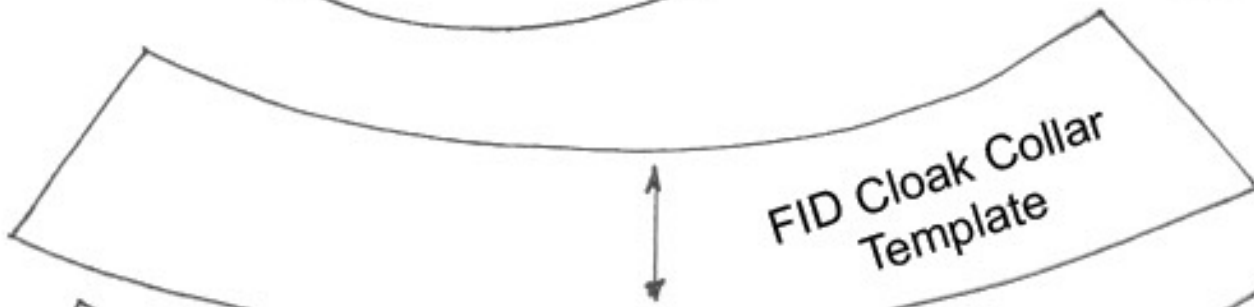
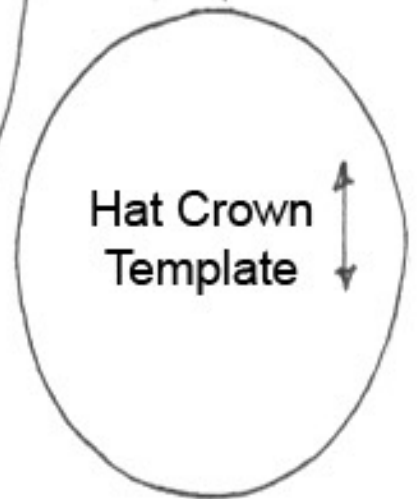
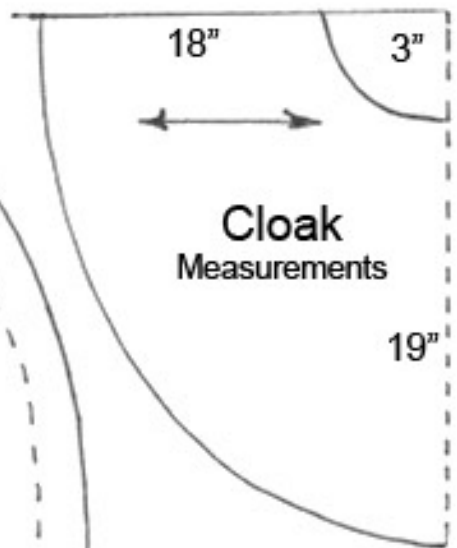
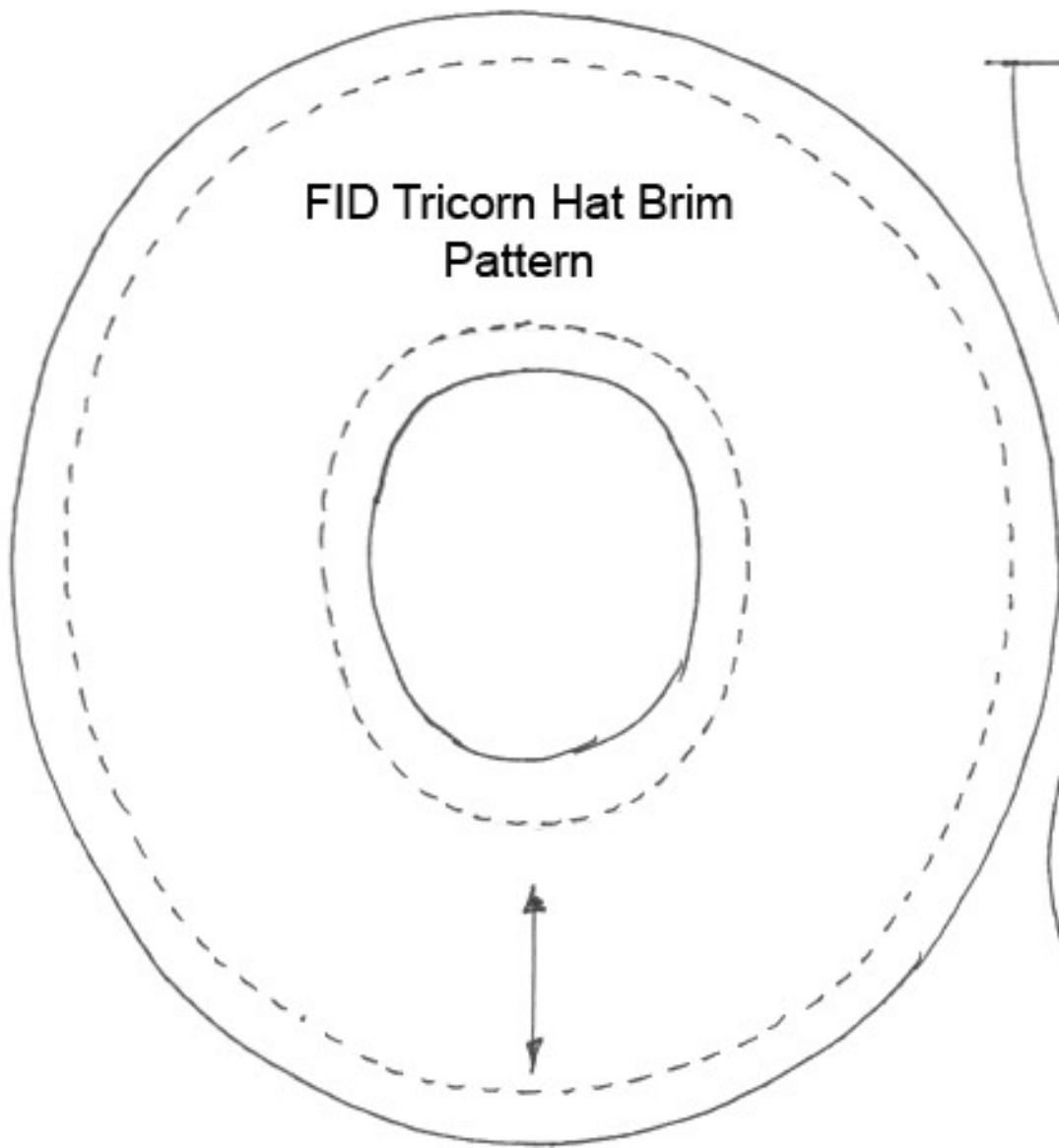

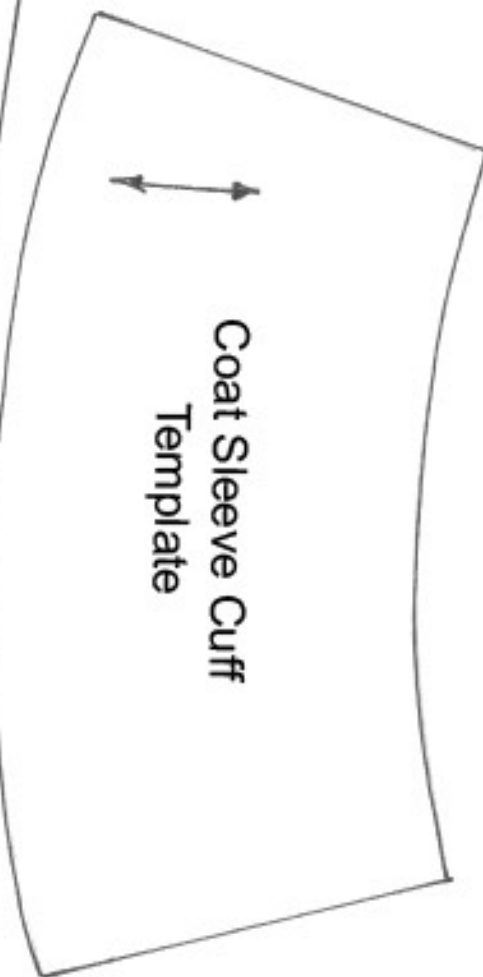
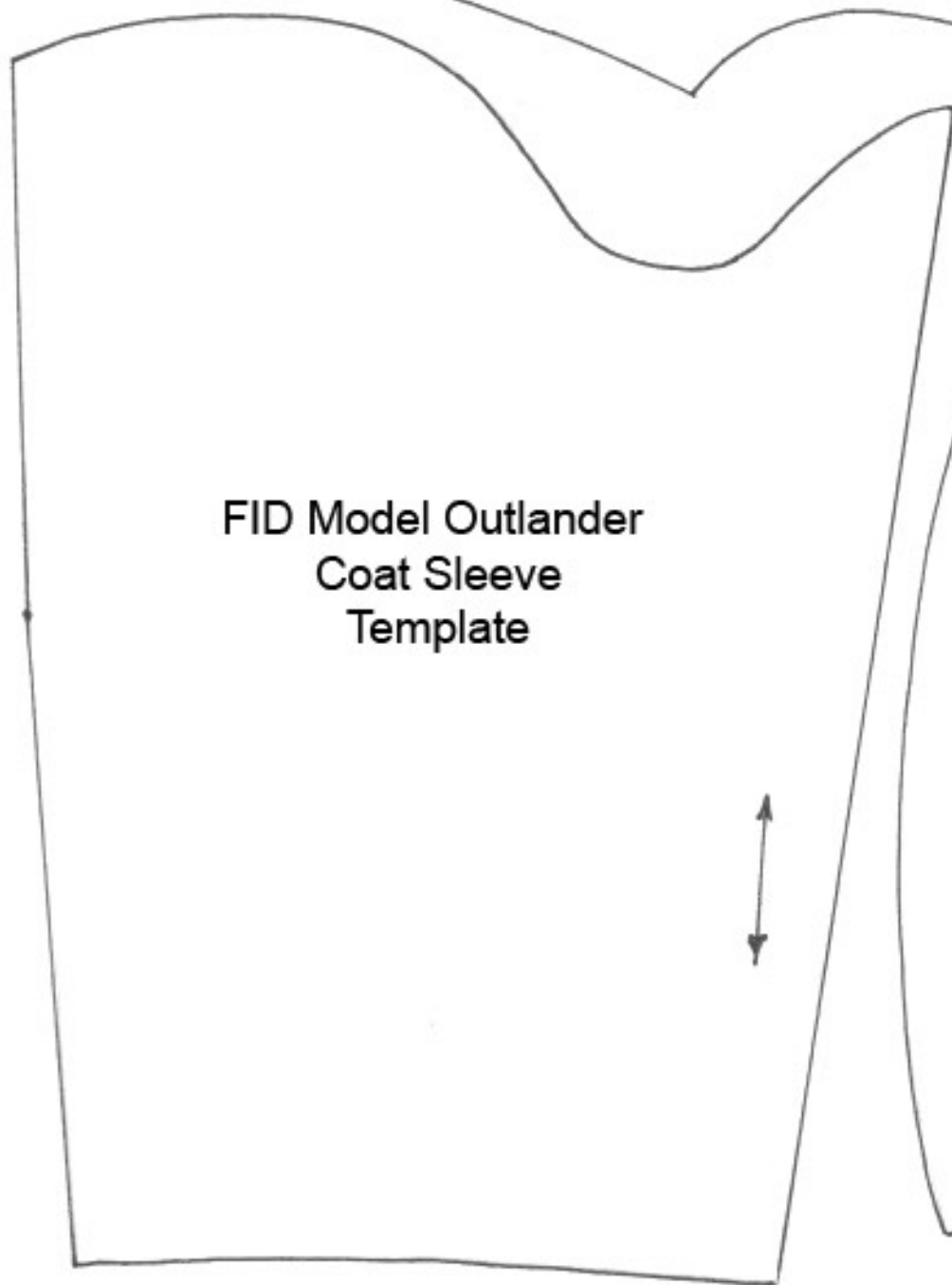
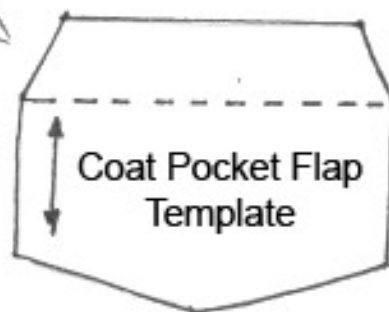
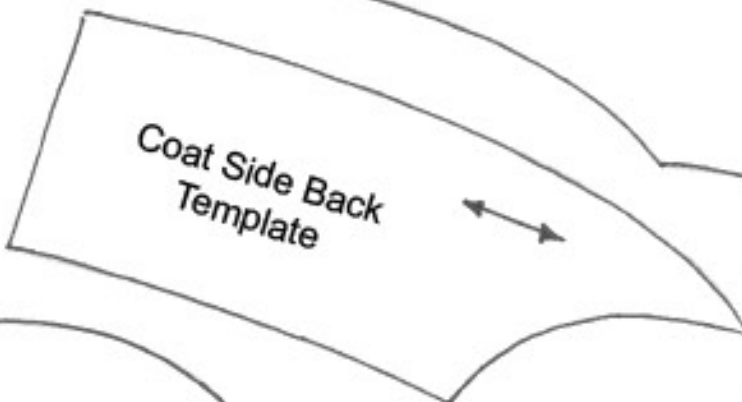
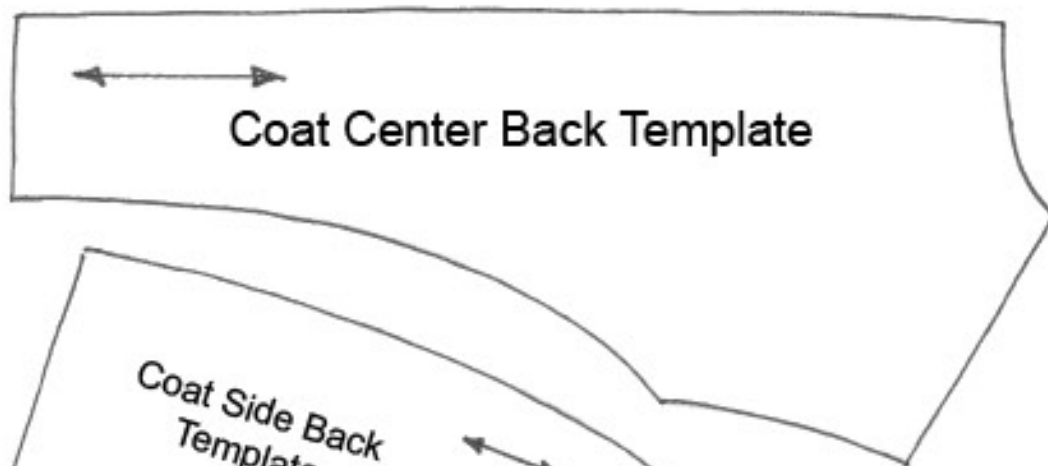

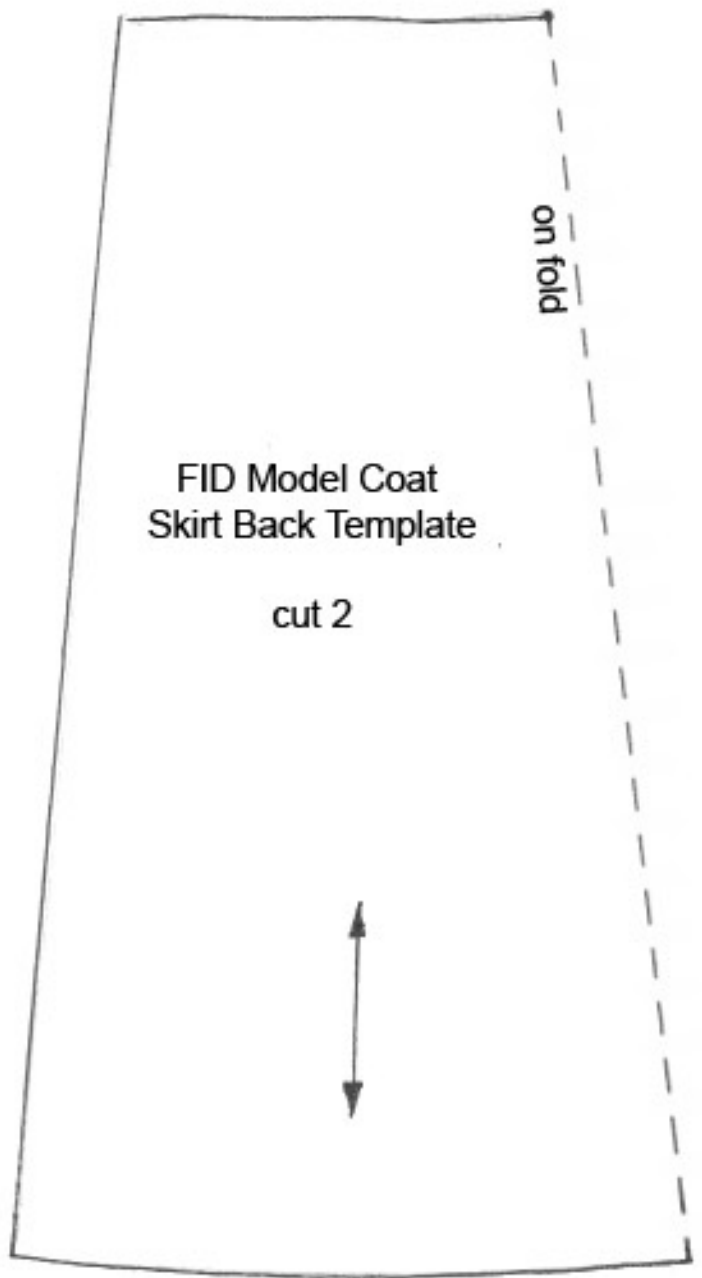
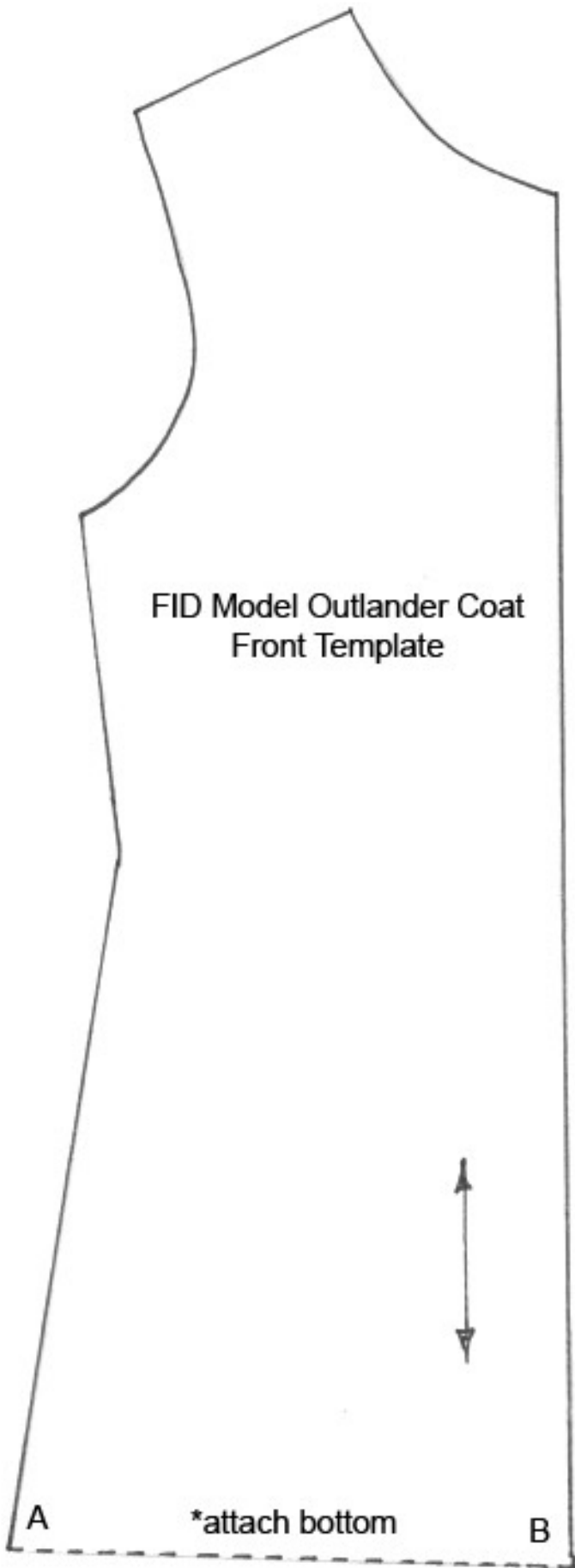

0
1
2
3
4 cm

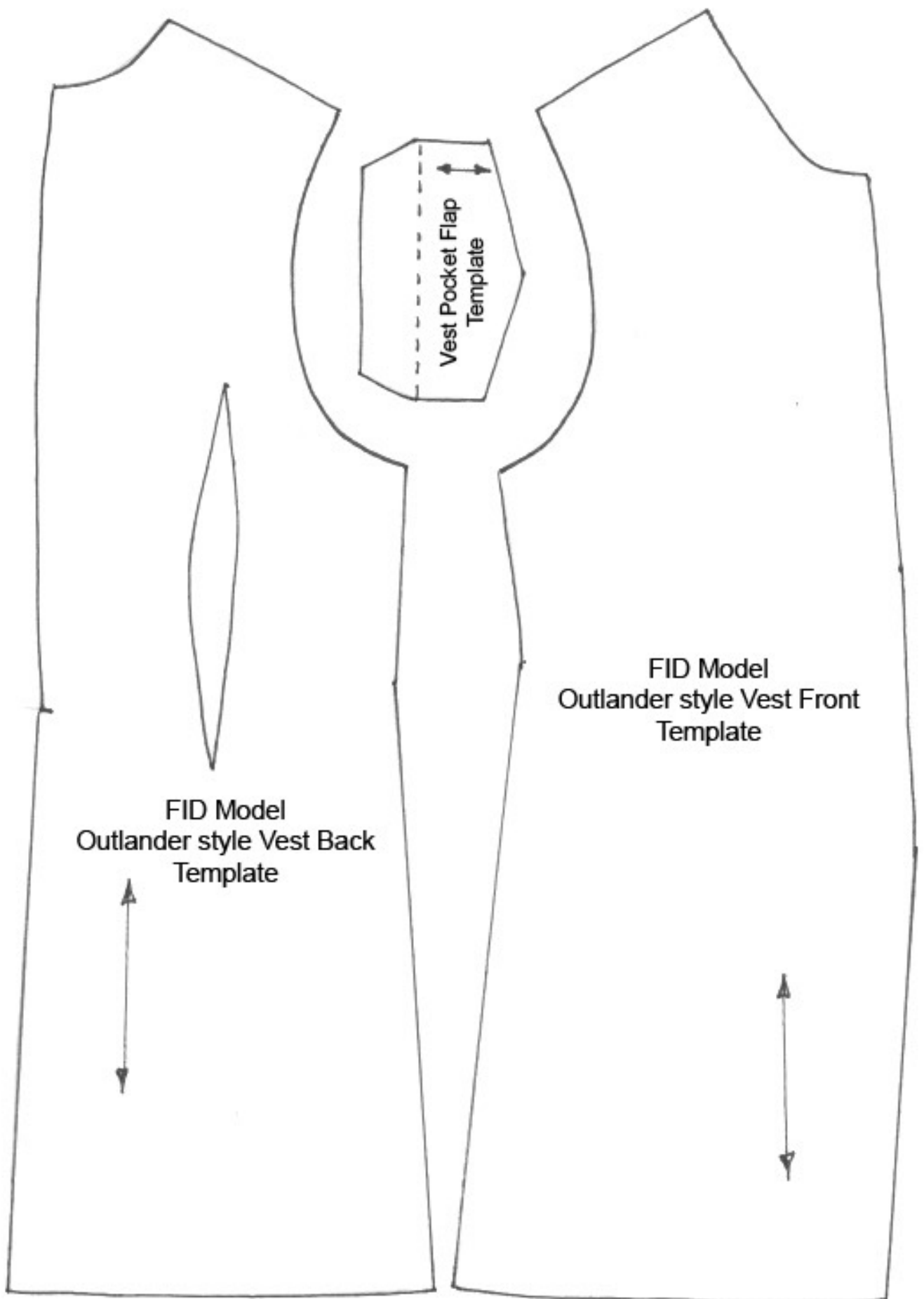

Vest Pocket Flap
Template

FID Model
Outlander style Vest Back
Template

FID Model
Outlander style Vest Front
Template

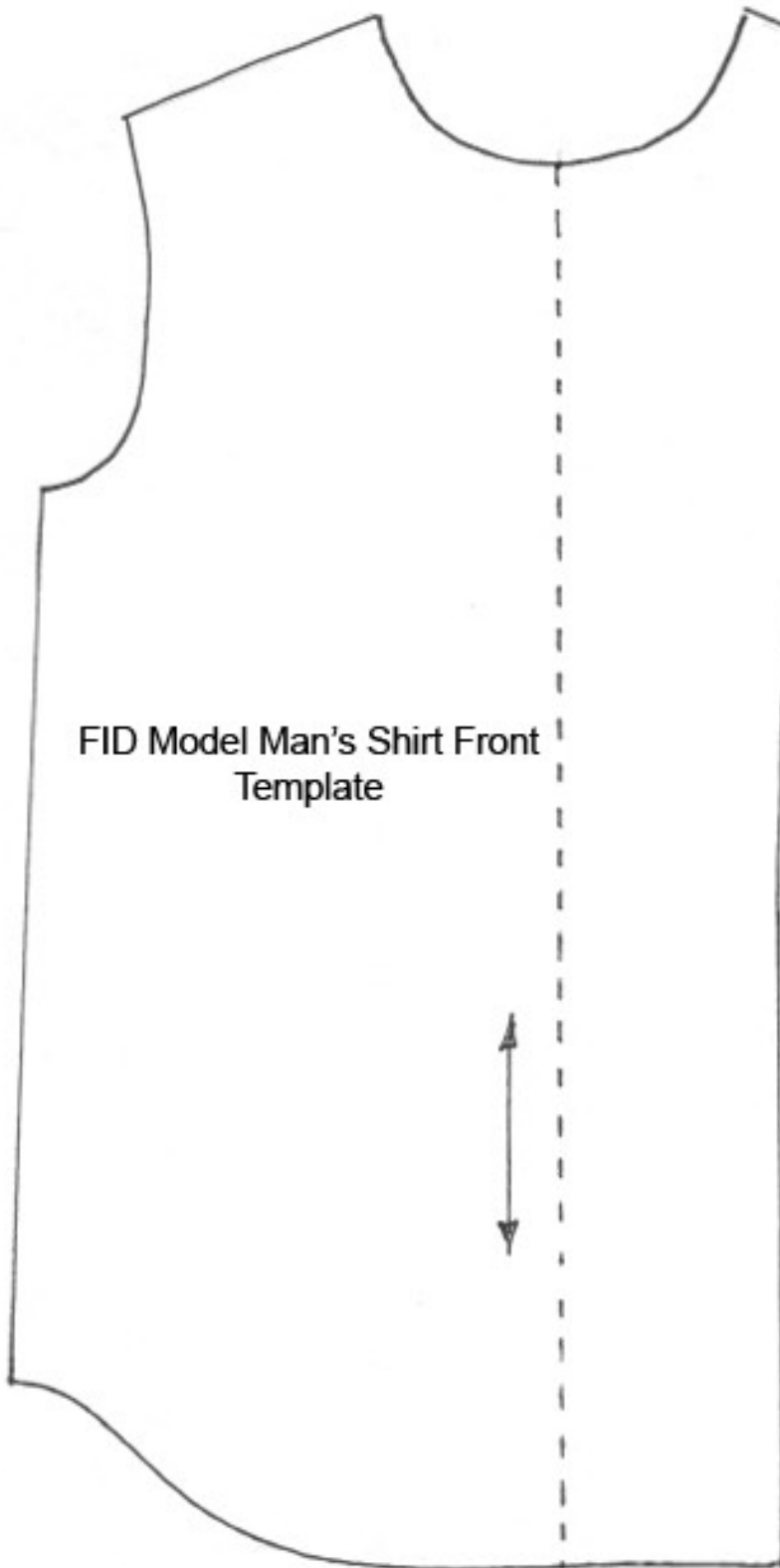

FID Model Man's Shirt Front
Template



Sleeve Cuff Pattern

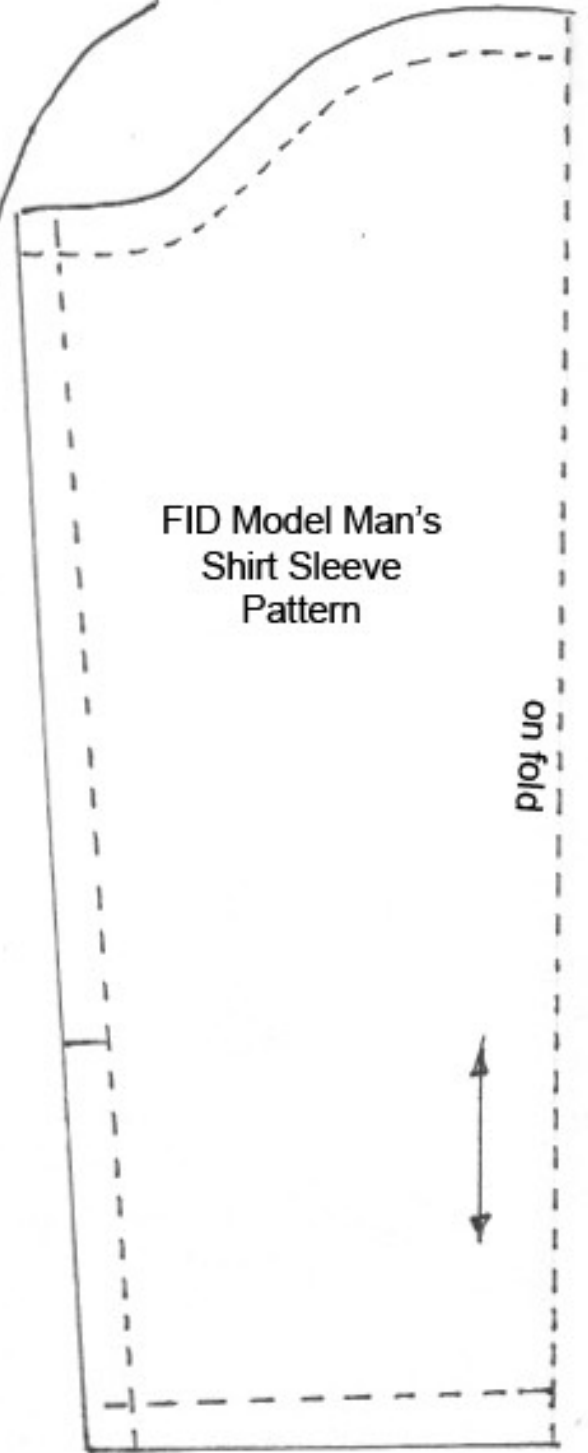

FID Model Man's
Shirt Sleeve
Pattern

on fold



